

DECTAPE
TRANSPORT TYPE TU55
CONTROL TYPE TC01

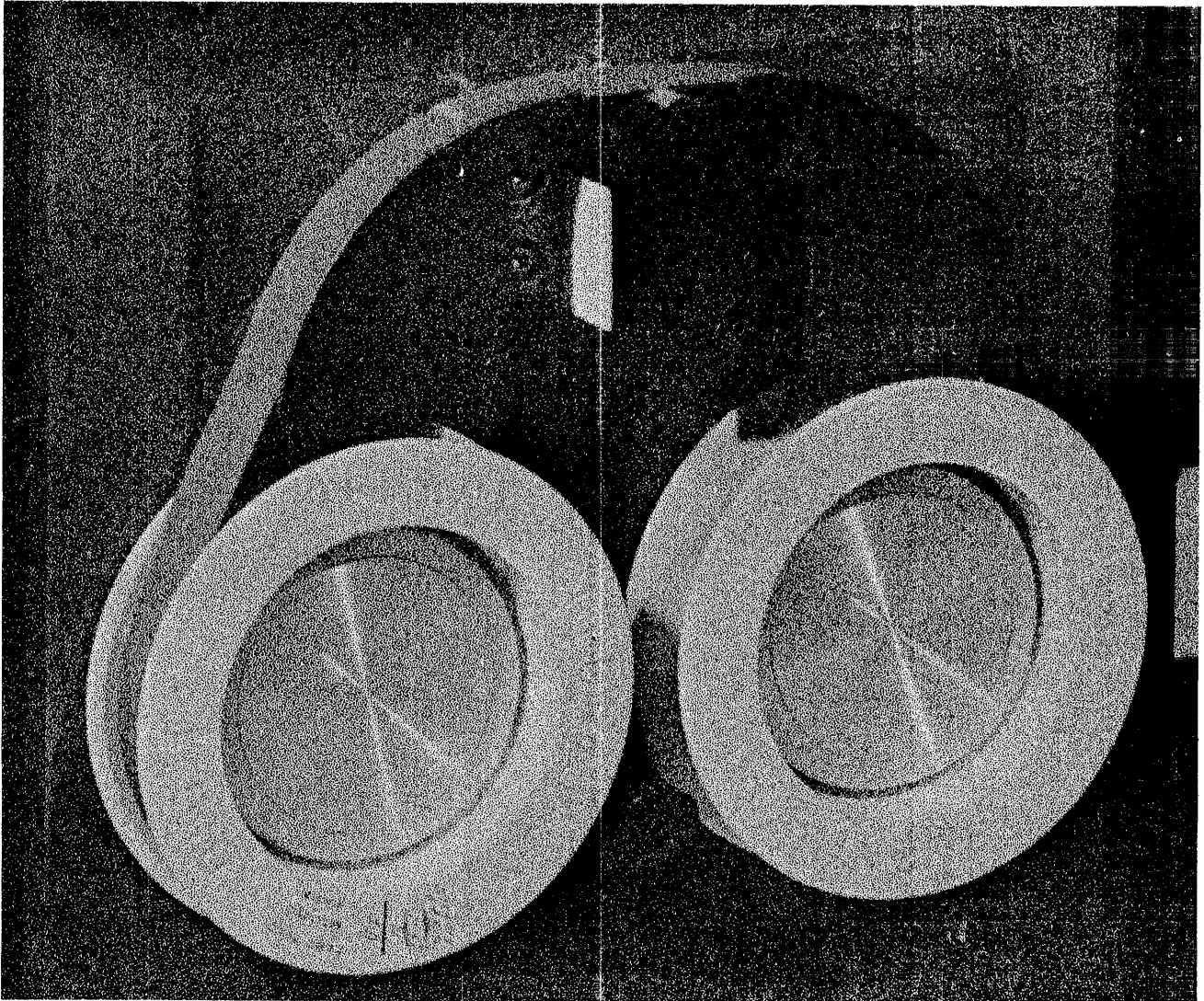

DECTape is a fast, convenient, reliable, low-cost input/output data storage facility and updating device. Special features include:

FIXED POSITION ADDRESSING permits selective updating of tape information as in magnetic disc or drum storage devices. Data blocks are numbered and completely addressable. Inter-record gaps are eliminated thereby increasing tape storage capacity.

AUTOMATIC WORD TRANSFERS use the PDP-8 block transfer control to allow concurrent information processing and data acquisition during block transfers at a 15-kc character rate.

SIMPLE TRANSPORT MECHANISM reduces maintenance requirements, improves reliability. DECTape's simple drive system requires no capstans, no pressure pad, and no mechanical buffering; therefore tape and head wear is minimal.

POCKET-SIZE REELS are handy to carry, easy to load.

Each 3-1/2 inch reel holds up to 3 million bits, the equivalent of 4,000 feet of paper tape, assuming 6-bit words are used.

BIDIRECTIONAL OPERATION saves time, provides easy access to stored information; reading, writing, and searching may be conducted in either direction.

REDUNDANT, PHASE RECORDING insures transfer reliability, reduces problem of skew in bidirectional operation. Each tape track is redundantly paired with a second, nonadjacent track. Use of phase (rather than amplitude) recording greatly reduces dropouts due to variations in amplitude.

PRERECORDED TIMING AND MARK TRACKS simplify programming, relieving the programmer of the responsibility of furnishing timing or counting instructions and permitting block and word addressability.

PRETESTED SUBROUTINES are available for information storage and retrieval, maintenance, and diagnostic tests.

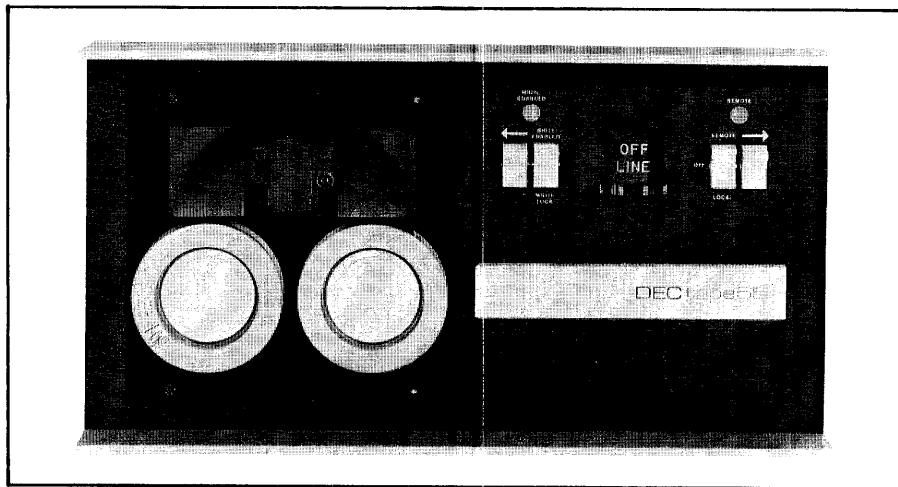

DECTAPE TRANSPORT TYPE TU55

The TU55 is a bidirectional magnetic-tape transport consisting of a read/write head for recording and playback of information on five channels of the tape. Connections from the read/write head are made directly to the external Control TC01 which contains the read and write amplifiers.

The logic circuits of the TU55 Transport control tape movement in either direction over the read/write heads. Tape drive motor control is exercised completely through the use of solid state switching circuits to provide fast reliable operation. These switching circuits contain silicon controlled rectifiers (SCR) which are controlled by normal DEC diode and transistor logic circuits. The function of these circuits is simply to control the torque of the two motors which transport the tape across the head according to the established function of the device, i.e., go, forward, reverse, or stop. In normal tape movement, full torque is applied to the forward or leading motor and a reduced torque is applied to the reverse or trailing motor to keep proper tension on the tape. Since tape motion

is bidirectional, each motor serves as either the leading or trailing drive for the tape, depending upon the forward or reverse control status of the TU55 Transport. A positive stop is achieved by an electromagnetic brake mounted on each motor shaft. When a stop command is given, the trailing motor brake latches to stop tape motion. Enough torque is then applied to the leading motor to take up slack in the tape.

Tape movement can be controlled by commands originating in a computer and applied to the TU55 Transport, by the TC01 DECTape Control, or by commands generated in manual operation of racker type switches located on the front panel of the transport. Manual control is used to mount new reels of tape on the transport, or as a quick maintenance check for proper operation of the control logic in moving the tape.

The solid state TU55 Transport is completely compatible with the older Type 555 Dual DECTape Transport and may be used to expand systems using the 555 Transport.

DECTAPE CONTROL TC01

The TC01 DECTape Control operates up to eight TU55 DECTape Transports. Binary information is transferred between the tape and the computer in 12-bit computer words approximately every $133\frac{1}{3}$ μ sec. In writing, the control disassembles 12-bit computer words so that they are written in four successive lines on tape. Transfers between the computer and the control always occur in parallel for a 12-bit word. Data transfers use the PDP-8 block transfer control (BTC) (3-cycle data break) facility of the computer. As the mark-track detection circuits detect the start and end of each block, the control raises a DECTape (DTCF) flag which causes a computer program in-

terrupt. The computer program uses the program interrupt to determine the block number. When it determines that the forthcoming block is the one selected for a data transfer, it selects the read or write control function. Each time a word is assembled or DECTape is ready to receive a word from the computer, the control raises a data flag. This flag is connected to the computer facility to signify a break request. Therefore, when each 12-bit computer word is assembled, the data flag causes a transfer via the BTC. By using the mark-channel decoding circuits and the BTC in this manner, computation in the main computer program can continue during tape operations.

DECTAPE FORMAT

DECTape utilizes a ten-track recording head to read and write five duplexed channels. Three of these track pairs are available for data; the two remaining pairs are used for timing and mark information. Duplication of each track by nonadjacent read/write heads wired in series eliminates most dropouts due to noise and dust and minimizes the effect of skew (see figure 1).

Key to the system is DECTape's mark channel which is used to raise flags, create data breaks, detect block mark numbers and block ends, and protect control portions of the tape. In addition, the mark channel provides DECTape with automatic bidirectional compatibility, variable length blocks, and end of tape sensing (see figure 2).

Information is stored on tape in block form (see figure 3). Block length is flexible and determined by information on the mark channel. A complete reel of tape, 849,036 lines, can be divided into any number of blocks up to 4096. Usually, a program which writes mark and timing information at specific locations establishes a uniform block length over the entire length of a reel of tape. However, the ability to write variable-length blocks is useful for certain data formats; e.g., where small blocks containing index or tag information need to be alternated with large blocks of data. Each block contains two types of words which are assembled by the TC01 Control. These are data and control words (see figure 4). Since DECTape has no inter-record gaps, control words separate the data portions of adjacent blocks. Control words occupy six lines* and are used to record address and checking information. They

provide compatibility between DECTape written on any of DEC's 12-, 18-, or 36-bit computers. Data words contain stored information and occupy four lines on tape (12 bits). To maintain compatibility with the mark channel format, data words are recorded in 12-line segments (12 being the lowest common multiple of 6-line marks and 4-line data words) which correspond to three 12-bit data words (see figure 5).

Block numbers normally occur in sequence from 1 to N. There is one block numbered 0 and one block N + 1. Programs are entered with a statement of the first block number to be used and the total number of blocks to be read or written. The maximum number of blocks is determined by the following equation in which N_B = decimal number of blocks, and N_W = number of words per block. (N_W must be divisible by 3).

$$N_B = \frac{212112}{N_W + 15} - 2$$

*As used on the PDP-8, only the last four lines of each control word are used.

Figure 1

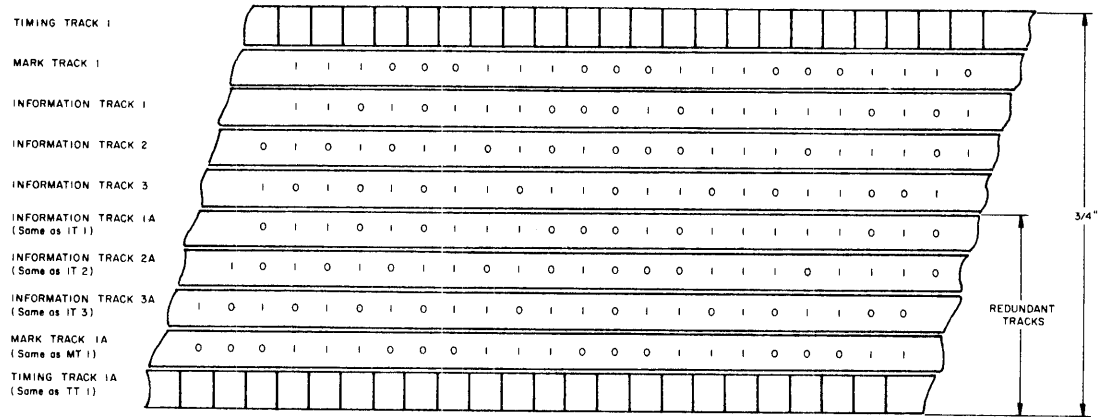

Figure 2

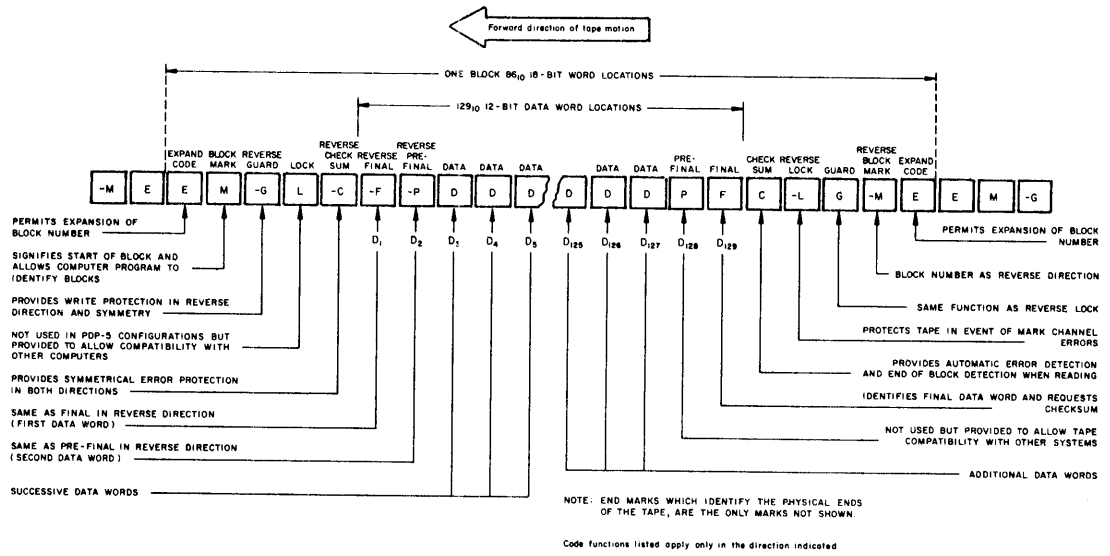

Figure 3

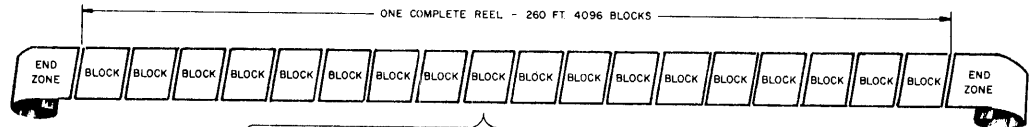

Figure 4

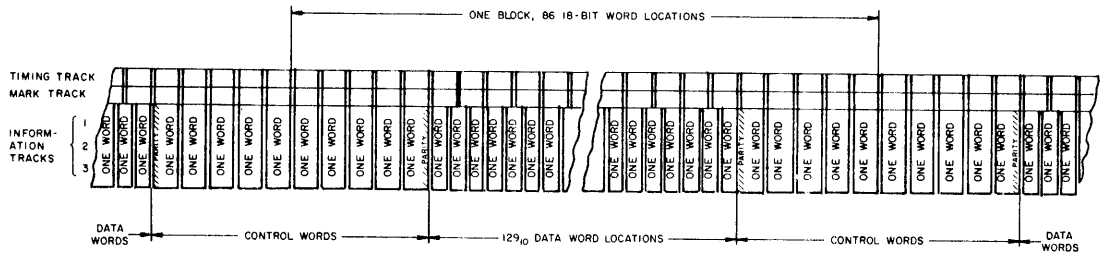
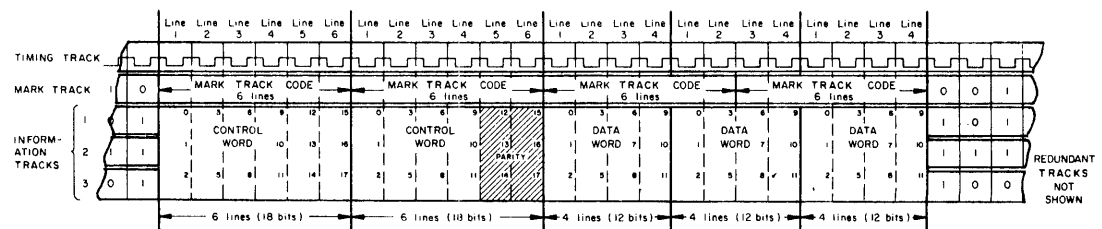

Figure 5



COMMAND AND INFORMATION FLOW IN THE DECTAPE SYSTEM

BLOCK TRANSFER CONTROL - The block transfer control in the PDP-8 controls the flow of data at high speeds between PDP-8 core memory and TC01 Control.

INFORMATION FLOW - A 12-bit databuffer in the TC01 Control synchronizes transfers between the TC01 and the PDP-8's block transfer control. A read/write buffer assembles and disassembles information passed between the TC01 data buffer and the tape.

COMMAND FLOW - The TC01 Control command status

register is loaded from and read by the PDP-8 accumulator. Unit selection, motion, function, interrupt enable, control flags, and error flags are loaded in this register.

In the TC01 Control, the control register receives commands from command status register, timing information from the time track read amplifier, and an interpretation of the information tracks from the mark track read amplifier. These inputs are then transformed into outputs to the PDP-8, the TU55 Transport, and the TC01 Control.

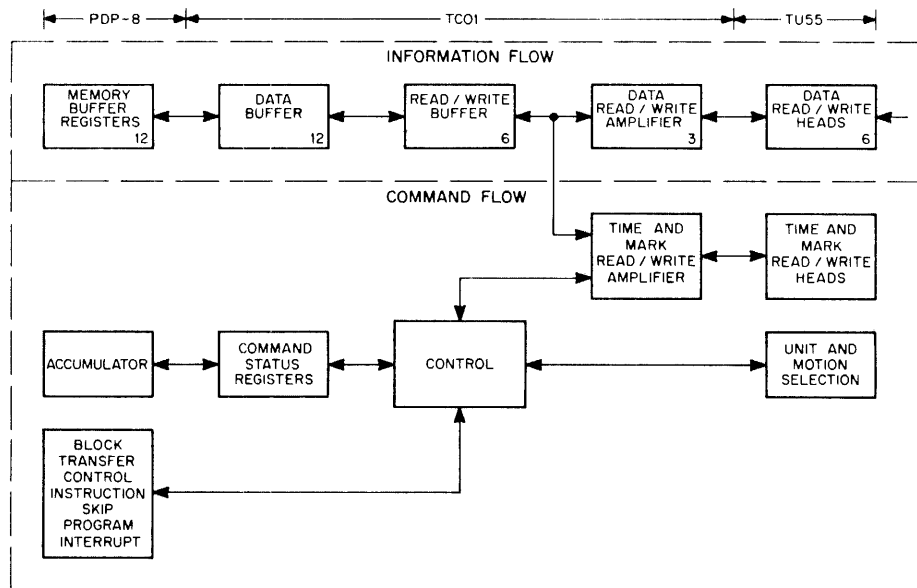

PROGRAMMING

Available Software

PDP-8 DECTape software has been developed with three basic goals in mind:

1. **SUBROUTINES** which the programmer may easily incorporate into a program for data storage, logging, data acquisition, data buffering (queuing), etc.
2. A **LIBRARY CALLING SYSTEM** for storing named programs on DECTape and a means of calling them with a minimal size loader.
3. **PROGRAMS FOR PREFORMATTING TAPES** controlled by the contents of the switch register to write the timing and mark channels, to write block formats, to exercise the tape and check for errors, and to provide ease of maintenance.

Program development in this area has resulted in a series of subroutines which read or write any number of DECTape blocks, read any number of 129-word blocks as 128 words (or one memory page), or search for any block (used by read and write, or to position the tape). These programs

are assembled with the user's program and are called by a jump to subroutine instruction. The program interrupt is used to detect the setting of the DECTape (DTF) flag thus allowing the main program to proceed while the DECTape operation is being completed. A program flag is set when the operation has been completed. Thus, the program effectively allows concurrent operation of several input/output devices along with the DECTape. These programs occupy two memory pages ($400_8 = 256_{10}$ words).

The Library System was developed with several design criteria in mind. First, the system should leave the state of the computer unchanged when it exits. Second, it should be capable of calling programs by name from the keyboard and allow for expansion of the program file stored on the tape. Finally, it should conform to existing system conventions; namely, that all memory except for the last memory page ($7600_8 - 7777_8$), be available to the programmer. This convention was established so that the Binary Loader (paper tape), and/or future versions of this loader could reside in memory at all times.

With these ideas in mind, the PDP-8 DECTape Library System was developed. It is loaded by a 17₁₀ instruction bootstrap routine that starts at 7600₈. This loader calls into the last memory page a larger program, whose function is to preserve on tape the contents of memory from 6000₈ - 7577₈ and then load the INDEX program and the directory into those same locations. Since the information in this area of memory has been preserved, it can be restored when operations have been completed. The skeleton system tape contains the following programs:

- INDEX Typing this causes the names of all programs currently on file to be typed out.
- UPDATE Allows the user to add a new program to the files. UPDATE queries the operator about the program's name, its starting address, and its location in core memory.
- GETSYS Generates a skeleton Library Tape on a specified DECTape unit.
- DELETE Causes a named file to be deleted from the tape.

Starting with the skeleton Library Tape, the user can build up a complete file of his active programs and continuously

update it. One of the uses of the Library Tape may be illustrated as follows:

A program is written in PDP-8 FORTRAN that is to be used repeatedly. The programmer may call the FORTRAN Compiler from the Library Tape and with it compile the program, obtaining the object program. The FORTRAN Operating System may then be called from the Library Tape and used to load the object program. At this time the Library program UPDATE is called, the operator defines a new program file (consisting of the FORTRAN Operating System and the object program), and adds it to the Library Tape. As a result, the entire operating program and the object program are now available on the DECTape Library Tape.

The last group of programs, a collection of short routines controlled by the contents of the switch register, is called DECTOG. It provides for the recording of timing and mark channels and permits block formats to be recorded for any block length. Patterns may be written in these blocks and then read and checked. Writing and reading is done in both directions and checked. Specified areas of tape may be "rocked" for specified periods of time. A given reel of tape may thus be thoroughly checked before it is used for data storage. These programs may also be used for maintenance and check-out purposes.

DECTAPE INSTRUCTION LIST

<u>Mnemonic</u>	<u>Octal</u>	<u>Operation</u>	<u>DTSF</u>	<u>6771</u>	<u>S K I P on DECTape CONTROL FLAG (DTCF) - The DTCF is the inclusive OR of the EF and the DTF. If EF (1) or DTF (1), the program counter is incremented and one instruction is skipped.</u>
DTRA	6761	READ STATUS A - Inclusive ORs the status A registers into the AC as shown in the status-A bit format. AC10-11 are undisturbed. All flags are left undisturbed.			
DTCA	6762	CLEAR STATUS A - Clears the status-A registers. All flags are left undisturbed.	DTRB	6772	READ STATUS B - Inclusive ORs the contents of the registers shown in the status-B format into the AC. All flags are left undisturbed.
DTXA	6764	XOR AC into STATUS A - The exclusive OR of the AC and status A is deposited in the status-A registers. If AC10 (0), EF is cleared. If AC11 (0), DTF is cleared. If AC10 (1) or AC11 (1) the respective flag is undisturbed. The AC is cleared.	DTLB	6774	LOAD STATUS B - the contents of AC6-8 are loaded into the memory field register. The AC is cleared. All flags are left undisturbed.

STATUS BIT FORMAT

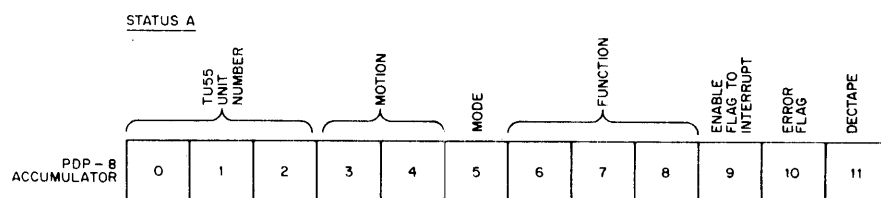

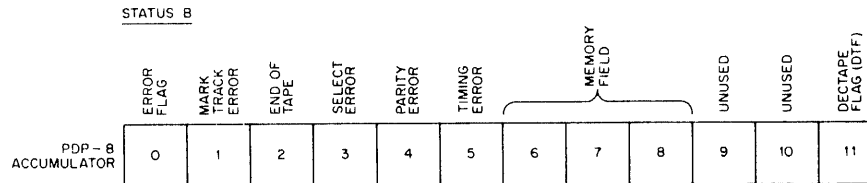

CONTROL MODES AND FUNCTIONS

Modes

NORMAL MODE (NM) - In NM the tape format controls the data transfers and flag raisings.
CONTINUOUS MODE (CM) - In CM the tape format and

the word count register in the block transfer control (located in PDP-8 core memory) control the data transfers and flag raisings.

Functions

MODE - Initiates movement of the selected transport tape in either direction. Mark-channel decoding is inhibited in this function except for end of tape.

SEARCH - As the tape is moved in either direction, sensing a block mark causes a data transfer of the block number. If in normal or continuous mode and the word count register has overflowed, the DECTape flag is set and causes a program interrupt. After finding the first block number, the continuous mode can be used to avoid all intermediate interrupts between the current and desired block numbers. This makes a virtually automatic search possible.

READ DATA - This function is used to transfer blocks of data into core memory with the transfer controlled by the tape format. In normal mode the DECTape flag is set at the end of a block and causes a program interrupt. In continuous mode transfers stop when the word count overflows (the rest of the block is read for parity checking) and then the DECTape flag is set.

READ ALL - Read all is used to read unusually formatted tape since it causes all lines to be read. In normal mode the DECTape flag is set at each data transfer. In continuous mode the DECTape is set when word-count overflow occurs. In either case the DECTape flag causes a program interrupt.

WRITE DATA - This function is used to write blocks of data with the transfer controlled by the standard tape format. The DECTape flag is raised as in read data.

WRITE ALL - Write all is used to write an unusual format (e.g., block numbers). The DECTape flag raisings are similar to read all.

WRITE TIMING AND MARK TRACK - This function is used to write on the timing and mark tracks. This permits blocks to be established or block lengths to be changed. The DECTape flag raisings are also similar to read all. This function is illegal unless a manual switch is on in the control.

PROGRAMMED OPERATION

Prerecording of a reel of DECTape, prior to its use for data storage, is accomplished in two passes. During the first pass, the timing and mark channels are placed on the tape. During the second pass, forward and reverse block-mark numbers, the standard data pattern, and the automatic parity checks are written. The DECTOG program performs these functions. Prerecording utilizes the write timing and mark channel control function and a manual switch in the control which permits writing on the timing and mark channels, activates a clock which produces the timing channel recording pattern, and enables flags for program control. Unless both this control mode and switch are used simultaneously, it is impossible to write on the mark or timing channels. An indicator lights on all transports associated with the control when the manual switch is in the "on" position. Under these conditions only, the write register and write amplifier used to write on information channel 1 (bits 0, 3, 6, and 9) are used to write on the mark channel. This operation of prerecording need only be performed once for a given reel of DECTape.

There are two registers in the TC01 DECTape Control that govern tape operation and provide status information to the operating program. The A-status register contains three unit-selection bits, two motion bits, the continuous mode/normal mode bit, three function bits, and three bits that control the flags. The B-status register contains three memory-field bits and the error status bits. PDP-8 IOT microinstructions are used to clear, read, and load these registers. In addition, there is an IOT skip instruction to test control status.

Since all data transfers between DECTape and the PDP-8 memory are controlled by the block transfer control (BTC), the program must set the word count (WC) and current address (CA) registers (locations 7754 and 7755 respectively) before a data transfer. After initiating a DECTape operation, the program should always check for error conditions (a program interrupt is initiated if the error flag to the interrupt system and the interrupt are enabled). The DECTape system should be started in the search mode to locate the block number selected for transfer and then,

when the correct block is found, the transfer is accomplished by setting the WC, CA, and the A-status register.

When searching, the DECTape control reads only block numbers. These are used by the operating program to locate the correct block number. In normal mode the DECTape flag is raised at each block number. In continuous mode the DECTape flag is raised only after the word count register reaches zero. The current address register is not incremented during searching, and the block number is placed in core memory at the location as specified by the contents of the current address register. Data is transferred to or from PDP-8 memory from locations as specified by the current address register which is incremented before each transfer.

When the start of the data position of the block is detected, the data flag is raised to initiate a data request to the block transfer control break each time the DECTape system is ready to transfer a 12-bit word. Therefore, the main computer program continues running but is interrupted approximately every $133\frac{1}{3}$ μ sec during a data break for the transfer of a word. Transfers occur between DECTape and successive core memory locations, commencing at the address previously set into C(CA)+1. The number of words transferred is determined by the tape format if in normal mode or by the word count register if in continuous mode.

At the conclusion of the data transfer the DECTape flag is raised and a program interrupt occurs. The interrupt subroutine checks the DECTape error bits to determine the validity of the transfer and either initiates a search for the next information to be transferred or returns to the main program.

During all normal writing transfers, a checksum (the 6-bit exclusive OR of the words in the data block) is computed automatically by the control and is automatically recorded as one of the control words immediately following the data portion of the block. This same checksum is used during reading to determine that the data playback and recognition takes place without error.

Any one of the eight tape drives may be selected for use by the program. After using a particular drive, the program can stop the drive currently being used and select a new drive, or can select another drive while permitting the original selection to continue running. This is a particularly useful feature when rapid searching is desired, since several transports may be used simultaneously. Caution must be exercised however, for although the earlier drive continues to run, no tape end detection or other sensing takes place. Automatic end sensing that stops tape motion occurs in all functions, but only in the selected tape drive.

SPECIFICATIONS

Tape Characteristics

CAPACITY - 260 ft of 3/4-in., 1-mil Mylar tape.

REEL DIAMETER - 2.8-in. empty reel, 3.9 in. for 260 ft of tape.

REEL DIAMETER RATIO - 1:4 (maximum to minimum)

TAPE HANDLING - Direct drive hubs and specially designed guides which float the tape over the head hydrodynamically. No capstans or pinch rollers are used.

SPEED - 97 \pm 14 ips.

DENSITY - 350 \pm 55 bpi.

INFORMATION CAPACITY - 2.7×10^6 bits per reel assembled into computer-length words by external DECTape control.

TAPE MOTION - Bidirectional.

TU55

OVERALL SIZE - 10-1/2 in. high, 19-1/2 in. wide, 9-3/4 in. deep.

MOUNTING - Standard 19-in. rack. Eight #10-32 screws mount chassis track assembly which holds transport. Chassis can be extended 16-3/4 in. beyond mounting surface for maintenance.

POWER REQUIREMENTS - -15 vdc, 10 amp maximum, +10 vdc, 50 ma maximum, 115 vac \pm 10%, 1.0 amp idle and 2.0 amp maximum current (60-cps models standard, 50-cps models on request).

CONNECTORS - Commands: two 18-terminal FLIP CHIP female connectors. Information: two 36-terminal FLIP CHIP female connectors.

COOLING - Internally mounted fan is provided.

OPERATING TEMPERATURE - 50 to 100°F ambient.

HUMIDITY - 10 to 90% relative humidity.

NOTE: The manufacturer of magnetic tape for DECTape recommends 40 to 60% relative humidity and 60 to 80°F as acceptable for operating environment.

Drive Characteristics

Times given are for 90% full speed.

START TIME - <200 msec.

STOP TIME - <150 msec.

TURN AROUND TIME - <200 msec.

Input Signals to Transport from Control

COMMANDS - FORWARD (negative level assertion), REVERSE (negative level assertion), GO (negative level assertion), STOP (negative level assertion), and ALL HALT (negative level assertion) used to stop transport when computer halts.

UNIT SELECT - SELECT 1 through SELECT 8 (ground level assertion).

CONTROL - POWER CLEAR standard DEC negative pulse to clear MOTION flip-flop when computer power is turned on.

Output Signal from Transport to Control

CONTROL - WRITE ENABLE standard DEC ground level for assertion.

TC01 Control

SIZE - 15-3/4 in. high and 19 in. wide for a control which operates eight TU55 Transports. (Requires three FLIP CHIP module mounting panels). A maintenance control is located on the right half of the top mounting panel.

POWER REQUIREMENTS - 115v, 60 cycles, 4 amp. The Type 779 Power Supply is included with the TC01 Control.

Cabinet

A maximum of one TC01 Control and four TU55 Transports can be installed in a standard DEC computer cabinet. Specifications for this configuration including appropriate power control and power supplies are:

SIZE - 69-1/8 in. high; 22-1/4 in. wide; 27-1/16 in. deep. Minimum clearances for door openings are 8-3/4 in. at the front; 14-7/8 in. at the back.

WEIGHT - 555 lbs.

POWER REQUIREMENTS - 115v, 60-cycle source capable of delivering 20 amps.